

V-TUF

M-CLASS MINI

M-CLASS DUST EXTRACTOR

M-CLASS MINI 110V

ITEM NO. M CLASS MINI 110V

M-CLASS MINI 240V

ITEM NO. M CLASS MINI 240V

OPERATING INSTRUCTIONS

**THIS GUIDE HAS BEEN DESIGNED TO HELP YOU GAIN AN UNDERSTANDING
OF THE DUST PROBLEM AND GET THE BEST USE OUT OF YOUR NEW
LUNG SAFE DUST VACUUM CLEANER**



SECTION 01: THE DUST PROBLEM, UNDERSTAND IT!

SECTION 02: THE V-TUF M-CLASS MINI OPERATORS MANUAL



V-TUF WOULD LIKE TO THANK

- ★ HSE, HSL and The Construction Dust Partnership for the incredible amount of analysis and excellent presentation of the problem. And for researching real solutions.
- ★ The Breathe Freely campaign by BOHS which helped make those at risk, aware.
- ★ The HAE (Hire Association Europe) for introducing control measures.
- ★ Training For Hire Ltd for expert market analysis and workshop awareness.

LOTS OF WORK HAS BEEN DONE ALREADY!

We would like to promote the helpful resources to the right and thank these leaders for their efforts in pioneering the following:

- ★ Discovery and analysis of the dust issue.
- ★ Identifying the symptoms.
- ★ Understanding and clarifying root causes.
- ★ Innovating solutions.
- ★ Creating awareness.
- ★ Providing support.
- ★ Providing Training.

WE'RE ONE OF MANY! THERE ARE MANY ORGANISATIONS LEADING POSITIVE CHANGE FOR BETTER HEALTH.



WWW.BSIF.CO.UK

WWW.HEALTHINCONSTRUCTION.CO.UK

**Imperial College
London**

WWW.IMPERIAL.AC.UK



BREATHE FREELY

WWW.BREATHEFREELY.ORG.UK



WWW.MAVISNYEFOUNDATION.COM

WWW.HEALTHINCONSTRUCTION.CO.UK

WWW.NOTIMETOLOSE.ORG.UK



V-TUF IS COMMITTED TO ELIMINATING DUST THROUGH THE DEVELOPMENT OF INNOVATIVE, EFFICIENT TOOLS AND METHODS FOR THE CONSTRUCTION INDUSTRY.

OUR MISSION IS TO EDUCATE, INNOVATE AND ERADICATE DUST ISSUES.

CONTENTS

THE DUST PROBLEM, UNDERSTAND IT!

| | | |
|-------|------------------------------------|---|
| 03 | WHAT IS DUST? | ● |
| 04 | IS DUST A PROBLEM? | ● |
| 05 | KNOW YOUR FOE | ● |
| 06 | BE PART OF M | ● |
| 07 | CONTROL MEASURES | ● |
| 08 | THINK SAFE | ● |
| 09 | CHALLENGES AND SOLUTIONS | ● |
| 10 | VALIDATED PROTECTION | ● |
| 11-12 | V-TUF® M-CLASS MINI SPECIFICATIONS | ● |

THE V-TUF® M-CLASS MINI OPERATORS MANUAL

| | | |
|-------|-------------------------------|---|
| 13-14 | OPERATORS MANUAL | ● |
| 15-20 | SET UP AND USE | ● |
| 21 | ABOUT YOUR MACHINE | ● |
| 22 | IMPORTANT INFORMATION | ● |
| 23 | THE M-CLASS CERTIFICATION | ● |
| 24 | TROUBLESHOOTING | ● |
| 25-26 | PARTS DIAGRAM AND LIST | ● |
| 27 | WARRANTY, RETURNS AND REPAIRS | ● |
| 28 | RETURNS AUTHORIZATION FORM | ● |
| 29 | EU DECLARATION OF CONFORMITY | ● |

ABOUT THE V-TUF® M-CLASS MINI AND M-CLASS REGULATIONS

HSE recently introduced the M-Class rating as the minimum legal requirement for construction vacuum cleaners. Unrated vacuum cleaners can be incredibly dangerous because, whilst they appear to do a good job in cleaning the majority of dust and debris, they can exhaust most of the dangerous, respirable dust back into the breathing space of the operator.

These minute particles of dust not only damage the motor of the vacuum cleaner, they cause a multitude of lung and health problems for the vacuum operator.

The V-TUF® M-CLASS MINI is a product of collaboration with SHE managers, Occupation Hygiene Specialists, Tradesmen, HSE Inspectors, Hire Specialists and many other people on the 'Front-Line' of construction to tackle this problem.

The V-TUF® M-CLASS MINI has been tested by respected laboratories including UK HSL (Health and Safety Laboratory), Intertek, Conformance and Eurofins to ensure it delivers compliance and performance at the right price.

CONTACT: CROFTON DRIVE, ALLENBY INDUSTRIAL ESTATE, LINCOLN, LN3 4NR, ENGLAND
VISIT WWW.V-TUF.COM FOR MORE INFORMATION

QUESTIONS?

PLEASE CONTACT OUR
TECHNICAL HELPLINE:
+44(0)1522 515767

(OPEN 9AM-4PM WEEKDAYS EXCLUDING HOLIDAYS)

DUST IS PARTICLES OF A MATERIAL RANGING FROM 1 TO 1000 MICRONS* IN SIZE

DUST IS CREATED BY WORKING WITH MATERIALS ON THE FOLLOWING TASKS:



SANDING



DRILLING



DEMOLITION



CUTTING



SWEEPING

DUST HAS TWO SIZE CLASSIFICATIONS

- 1 Total inhalable dust (up to 100 microns). This can be inhaled into the respiratory tract.
- 2 Respirable dust (up to 10 microns). This is normally invisible in standard light and can remain airborne for up to 8 hours. Because of its weight and size it can be inhaled right into the lungs where the oxygen is processed.

THERE ARE THREE MAIN TYPES OF CONSTRUCTION DUST





- 1 Silica dust (Respirable Crystalline Silica or RCS) comes from materials containing silica such as sandstone, concrete and mortar.
- 2 Wood dust comes from wood and wood-based products like MDF and plywood. Wood based products can be more dangerous because they contain other elements like glue, etc...
- 3 Lower toxicity dusts come from materials containing very little or no silica such as dolomite, plasterboard and marble.

*A MICRON OR MICROMETRE IS ONE MILLIONTH OF A METER, SYMBOLISED AS: μ , MU.

IN THE UK, EVERY YEAR:







-  - 110 fresh cases of dust-related skin disease.
-  - 177 fresh cases of occupational asthma.
-  - Around 700 people die from exposure to silica dust.
-  - 1300 die from occupational lung disease & cancer.
-  - 8000 die from dust-related illnesses.
-  - That's more than die from road accidents.
-  - £1.1 billion lost on workplace injury and poor health in the construction industry.

THE CONSTRUCTION INDUSTRY:

-  - Contributes to 4% of total particulate emissions.
-  - Encounters dust throughout all trades.
-  - Is responsible for 40% of occupational cancer deaths and registrations.
-  - Loses 2.3 million working days due to fatalities and serious illness.



DID YOU KNOW?

-  The most dangerous dust is referred to as 'respirable dust' (up to 10 microns).
-  This dust can't be seen and remains airborne for up to 8 hours. If you've ever cleaned up, and returned to a job the next day to find it covered in dust again, this is respirable dust.
-  Anything that gets stuck in your nose or throat is called 'inhalable dust' (up to 100 microns). This is not as dangerous because it doesn't reach your lungs. However this dust can be harmful if it contains toxic substances like lead.
-  1000s of vacuum cleaner motors are damaged from dust every year.
-  Silica is found in most construction products (see page 6).
-  Sweeping up exposes you to 4 times more dust than the original task.

CONTACT: CROFTON DRIVE, ALLENBY INDUSTRIAL ESTATE, LINCOLN, LN3 4NR, ENGLAND
VISIT WWW.V-TUF.COM FOR MORE INFORMATION

QUESTIONS?

PLEASE CONTACT OUR
TECHNICAL HELPLINE:
+44(0)1522 515767

(OPEN 9AM-4PM WEEKDAYS EXCLUDING HOLIDAYS)

FREQUENT INHALATION OF AIRBORNE PARTICLES OF THE FOLLOWING SUBSTANCES WILL HARM YOU!

| MATERIAL | APPROX. CRYSTALLINE SILICA CONTENT |
|-------------------|------------------------------------|
| SANDSTONE | 70 - 90% |
| CONCRETE / MORTAR | 25 - 75% |
| TILE | 30 - 45% |
| GRANITE | 20 - 45% (Typically 30%) |
| SLATE | 20 - 40% |
| BRICK | 30% |
| LIMESTONE | 2% |
| MARBLE | 2% |



DID YOU KNOW?

Some paints contain lead. Lead is poisonous when it is inhaled or ingested. Removing (sanding, scraping etc.) old paint can also be highly poisonous!



BE AWARE!

Dangerous dust particles (respirable dust - up to 10 microns) are normally invisible in standard light and can remain airborne for up to 8 hours. Because of their weight and size, they can be inhaled right into the lungs where the oxygen is processed causing serious lung damage over time.



RCS (RESPIRABLE CRYSTALLINE SILICA) IS THE SECOND BIGGEST KILLER OF CONSTRUCTION WORKERS AFTER ASBESTOS!



V-TUF IS COMMITTED TO ELIMINATING DUST THROUGH THE DEVELOPMENT OF
INNOVATIVE, EFFICIENT TOOLS AND METHODS FOR THE CONSTRUCTION INDUSTRY.

OUR MISSION IS TO EDUCATE, INNOVATE AND ERADICATE DUST ISSUES.



WHY M-CLASS?

M-Class certified equipment has the following benefits:

- ✓ Have sufficient air velocity to extract, transport and collect dust.
- ✓ Have sufficient filtration to ensure that you don't pump dangerous dust back into the air. Unrated vacuum cleaners can exhaust up to 85% of the dangerous/respirable dust back into your breathing space.
- ✓ Have a safe waste disposal method.

PROOF OF M-CLASS

M-Class certified equipment must:

- ✓ Have a clear method of notifying the user when the air flow drops below 20 metres per second (this is normally an audible or visual signal). Without a method of notifying you about low air flow, you could have your extractor connected but not be extracting harmful dust because your bag is full or your filter is blocked.
- ✓ Have a minimum filter efficiency of 99.9% and a minimum of H12 HEPA (High-Efficiency Particulate Arrestance) Filtration. **To be safe the V-TUF[®]M uses HEPA H13 grade.**
- ✓ Have an airtight air-channel to ensure that contaminated air does not bypass the filter. This includes no holes in the filter and a total air-tight seal.
- ✓ Have a dust bag with a 'shut off' tap. This provides safe collection and easy disposal of bulk waste. This also protects the filter and reduces the time it takes to clog up.
- ✓ Have a safe method of cleaning the filter. For example: a filter shaker or a system where water/air can be used (bear in mind that the filter must only be cleaned in an isolated air space!)



CONTACT: CROFTON DRIVE, ALLENBY INDUSTRIAL ESTATE, LINCOLN, LN3 4NR, ENGLAND
VISIT WWW.V-TUF.COM FOR MORE INFORMATION

QUESTIONS?

PLEASE CONTACT OUR
TECHNICAL HELPLINE:
+44(0)1522 515767

(OPEN 9AM-4PM WEEKDAYS EXCLUDING HOLIDAYS)

AVOID

Avoid making RCS dust by using silica free materials or buying the right size of materials to avoid cutting. If you can't avoid making RCS dust, you must do everything practically possible to...

PREVENT

Prevent exposure by using water suppression equipment to convert the dust to slurry, sweeping up using the correct floor extraction tool or using "on tool dust extraction". This removes the dust as it is created. To achieve this you need to:

- 1 Choose tools that have a collection cover and extraction port.
- 2 Connect your tool to an M Class certified extraction unit.

If you cannot prevent RCS exposure, you must...

MINIMISE

Minimise exposure to as low a level as is reasonably practical by:

- 1 Arresting dust with mist.
(Note: Water particle size must be similar to the respirable dust particle size to be effective).
- 2 Using an air filter cube to rotate and clean the air.
- 3 Using less powerful tools.
- 4 Wearing the correct respiratory protection equipment (RPE) - This is by no means the most effective solution but can be used if you have no other way of eliminating dust as it only aids individuals wearing the equipment. You must ensure that you aren't harming anyone else.





BE AWARE AND MAKE AWARE!

- 1 Exercise the **Avoid, Prevent, Minimise** control measures.
- 2 Use “on tool dust extraction” to remove dust as it is created.
- 3 Use “on tool water suppression” equipment to convert the dust to slurry.
- 4 Use an M-Class extractor with floor tool rather than sweeping, as sweeping releases dust into the air.
- 5 If you have to create dust, isolate the area with polythene sheeting and use respiratory protection equipment (RPE). Then either vacate the area for 8 hours, or clean the air with mist or an air filter cube. Be sure to use dust detection equipment as the most dangerous dust is invisible!
- 6 Take care of yourself and your colleagues.

CONTACT: CROFTON DRIVE, ALLENBY INDUSTRIAL ESTATE, LINCOLN, LN3 4NR, ENGLAND
VISIT WWW.V-TUF.COM FOR MORE INFORMATION

QUESTIONS?

PLEASE CONTACT OUR
TECHNICAL HELPLINE:
+44(0)1522 515767

(OPEN 9AM-4PM WEEKDAYS EXCLUDING HOLIDAYS)

CONTROL MEASURES AREN'T ALWAYS PRACTICAL OR ATTRACTIVE. THE V-TUF® M-CLASS MINI IS HERE TO HELP YOU COMPLETE THE FOLLOWING TASKS SAFELY:

| | |
|--------------------|--|
| DUSTLESS SWEEPING | Use the V-TUF® M-CLASS MINI to quickly sweep all debris into the corner of the room for safe collection. Traditional sweeping creates huge amounts of respirable, airborne dust. With the V-TUF® M-CLASS MINI, this dangerous dust is contained within the vacuum bag. The V-TUF® M-CLASS MINI Hard Floor Sweeper Head guarantees a quicker clean with a better result and, most importantly, protects your lungs. |
| ON-TOOL EXTRACTION | V-TUF® M-CLASS MINI comes with a universal power tool adaptor to connect directly to your power tool and remove respirable dust at source. This tool enables you to work quicker, cleaner and safer. |
| CARPET CLEANING | V-TUF® M-CLASS MINI comes with a special carpet cleaning head, allowing you to clean your carpets thoroughly and bag all the horrible things that cause/trigger dust allergies. |
| CLEANING STAIRS | The V-TUF® M-CLASS MINI makes stair cleaning simple and safe. Traditional stair sweeping can be dangerous as this task is often carried out closer to your immediate breathing space. |
| SANDING | Connect V-TUF® M-CLASS MINI to your sanding equipment to extract dust at source! There are many devices available on the market, with extraction ports, the M-CLASS MINI has been specifically designed to work with these. Give us a call if you need help or advice. |
| DRILLING | There are some great dustless drilling solutions on the market: drill bits with extraction, dust collection hoods, etc. V-TUF® M-CLASS MINI has been designed to attach to these to take away harmful dust from the immediate source. |
| DRAIN CLEANING | V-TUF® M-CLASS MINI comes with a handy blow feature. This blows pure, filtered air can be used for a wide range of application, such as: unblocking drains (a great alternative to poking things down the pipe), blowing leaves or even pumping up your paddling pool! |
| SAFE COLLECT | Ask us to keep you up-to-date with our Shovac®! This scoop will connect to the V-TUF M-CLASS MINI and will help to remove any respirable dust that plumes during debris collection. |

WE ARE PEDANTIC ABOUT VALIDATION!

As such, we have in-house testing facilities and we work with respected laboratories including UK HSL (Health and Safety Laboratory), Intertek, Conformance and Eurofins to ensure the V-TUF® M-CLASS MINI delivers compliance and performance at the right price.



GIVE US YOUR CHALLENGES AND IDEAS AND WE WILL DEVELOP AND CERTIFY THEM WITH YOU

**CONTACT: CROFTON DRIVE, ALLENBY INDUSTRIAL ESTATE, LINCOLN, LN3 4NR, ENGLAND
VISIT WWW.V-TUF.COM FOR MORE INFORMATION**

QUESTIONS?

**PLEASE CONTACT OUR
TECHNICAL HELPLINE:
+44(0)1522 515767**

(OPEN 9AM-4PM WEEKDAYS EXCLUDING HOLIDAYS)

V-TUF M-CLASS MINI SPECIFICATIONS 11



▲ COMES WITH COMPLETE ACCESSORY KIT

WHY BUY M-CLASS?

PROTECT YOUR HEALTH, PROTECT YOUR VACUUM, BE COMPLIANT AND DO YOUR JOB EFFECTIVELY WITH V-TUF® M-CLASS MINI

The V-TUF® M-CLASS MINI helps you tackle dust at the source. Connect it directly to your power tools or sweep up and enjoy a dust free environment. The V-TUF® M-CLASS MINI is certified to M-Class, the new 'Minimum Legal Requirement' for construction sites. Unrated vacuum cleaners are extremely dangerous as respirable dust can pass through the motor and be pumped back into the air. This dust then remains airborne for up to 8 hours, where it can be inhaled directly into your lung chamber, where it will remain forever.

Approximately 700 people in the UK die every year due to illness relating to the inhalation of respirable dust. Needless to say, this dust also damages your vacuum motor. The V-TUF® M-CLASS MINI offers you affordable compliance and protection from common dust related health issues!



ON TOOL EXTRACTION



SWEEP EXTRACTION

SELECTED FEATURES



M CLASS RATED

The M-CLASS MINI has been third party tested and certified to M Class standards. The UK Health and Safety executive has recently introduced this rating as the minimum legal requirement for all construction sites.



99.9% FILTRATION EFFICIENCY

Unrated vacuum cleaners can exhaust up to 85% of harmful dust back into your breathing space. This dust can't be seen by the naked eye and remains airborne for up to 8 hours. The M-CLASS MINI filter protects your motor and your health!



EXTRACTION VELOCITY MONITOR

To sufficiently extract dust at source, you need a minimum extraction velocity of 20 metres per second. M-CLASS MINI will notify you if the air flow drops below this level to keep you working efficiently.



INTEGRATED FILTER SHAKER SYSTEM

M-CLASS MINI helps you to unclog the filter without exposing yourself to harmful dust by using an integrated Filter Shaker System. And if you ever need to give the filter a good, deep clean: simply remove the filter and place it in the dishwasher!



UNIVERSAL POWER TOOL CONNECTOR

M-CLASS MINI comes with a universal power tool connector enabling you to extract dust from any power tool with a collection shroud and suction port!



HANDY BLOW FEATURE

M-CLASS MINI comes with a handy blow feature. This blows pure, filtered air and can be used for a wide range of applications, such as: unblocking drains, blowing leaves or even pumping up your paddling pool!

V-TUF

V-TUF IS COMMITTED TO ELIMINATING DUST THROUGH THE DEVELOPMENT OF INNOVATIVE, EFFICIENT TOOLS AND METHODS FOR THE CONSTRUCTION INDUSTRY.

OUR MISSION IS TO EDUCATE, INNOVATE AND ERADICATE DUST ISSUES.

LUNG SAFE DUST VACUUM CLEANER

12

ACCESSORIES LIST

THE V-TUF® M-CLASS MINI COMES WITH A WIDE RANGE OF ACCESSORIES TO HELP YOU UNDERTAKE ANY JOB EFFICIENTLY AND, MOST IMPORTANTLY, SAFELY!

A FULL LIST OF ACCESSORIES CAN BE FOUND BELOW:



SPECIFICATIONS

| | |
|---------------------|--------------------------------|
| CABLE LENGTH: | 5 metres |
| MOTOR POWER: | 800W |
| VOLTAGE: | 11/240V – 50/60Hz |
| AIR FLOW: | Measured at 20-25L/sec |
| LIFT POWER: | 2400mm / 18kPa |
| TANK SIZE: | 15L – 8.5L (dry waste) |
| WEIGHT: | Gross: 7Kg New 6Kg |
| FILTRATION: | M-Class Certified |
| NOISE: | 76dB |
| DIMENSIONS: | D: 360mm W: 340mm H: 420mm |
| PACKAGE DIMENSIONS: | D: 370mm W: 400mm H: 430mm |

| PRODUCT NAME | SUPPLIER REF. |
|---|---------------|
| 110 Volt Dust Safe Vacuum Cleaner – M-Class | VTM110 |
| 240 Volt Dust Safe Vacuum Cleaner – M-Class | VTM1240 |
| 1 Protected M-Class Filter – Washable | VTM102 |
| 2 Dust Bag (Pack of 5) | VTM101 |
| 3 3m Yellow 32mm Hose | VTM104 |
| 4 Complete Handle – 2x Straight Extensions + 1x Elbow | VTM105 |
| 5 Carpet / Hard Floor Head | VTM106 |
| 6 Hard Floor Sweeper Head | VTM107 |
| 7 Crevice Tool / Brush Attachment | VTM108 |
| 8 Universal Stepped PowerTool Adaptor | VTM103 |

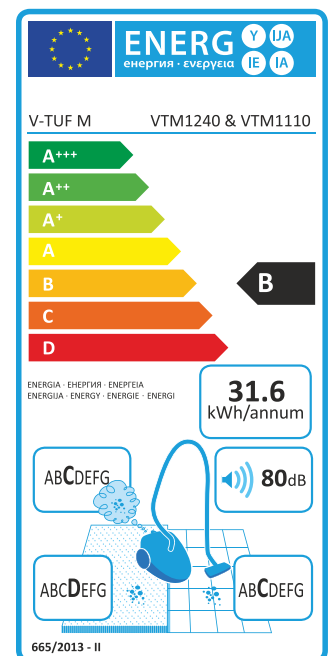

CONTACT: CROFTON DRIVE, ALLENBY INDUSTRIAL ESTATE, LINCOLN, LN3 4NR, ENGLAND
VISIT WWW.V-TUF.COM FOR MORE INFORMATION

QUESTIONS?

PLEASE CONTACT OUR
TECHNICAL HELPLINE:
+44(0)1522 515767

(OPEN 9AM-4PM WEEKDAYS EXCLUDING HOLIDAYS)

INTRODUCTION

Congratulations on becoming the owner of a V-TUF[®] M-CLASS MINI Lung Safe Dust Extraction vacuum cleaner. Please read this manual to ensure your get the best performance and protection from your machine.

IF YOU HAVE FURTHER QUESTIONS, PLEASE CONTACT OUR CUSTOMER SERVICE TEAM ON +44(0)1522 515767.

HAPPY READING AND GOOD HEALTH!



V-TUF IS COMMITTED TO ELIMINATING DUST THROUGH THE DEVELOPMENT OF INNOVATIVE, EFFICIENT TOOLS AND METHODS FOR THE CONSTRUCTION INDUSTRY.

OUR MISSION IS TO EDUCATE, INNOVATE AND ERADICATE DUST ISSUES.



PARTS INCLUDED



| PRODUCT NAME | SUPPLIER REF. |
|--|--------------------------------------|
| 1 110 Volt or 240 Volt Dust Safe Vacuum Cleaner – M-Class | M-CLASS MINI 110 or M-CLASS MINI 240 |
| 2 Protected M-Class Filter – Washable | VTM102 |
| 3 Dust Bag (Pack of 5) | VTM101 |
| 4 3m Yellow 32mm Hose | VTM104 |
| 5 Complete Handle – 2x Straight Extensions + 1x Elbow | VTM105 |
| 6 Carpet / Hard Floor Head | VTM106 |
| 7 Hard Floor Sweeper Head | VTM107 |
| 8 Crevice Tool / Brush Attachment | VTM108 |
| 9 Universal Stepped PowerTool Adaptor | VTM103 |

See page 25 for a full breakdown of parts and more information.

**CONTACT: CROFTON DRIVE, ALLENBY INDUSTRIAL ESTATE, LINCOLN, LN3 4NR, ENGLAND
VISIT WWW.V-TUF.COM FOR MORE INFORMATION**

QUESTIONS?

**PLEASE CONTACT OUR
TECHNICAL HELPLINE:-
+44(0)1522 515767**

(OPEN 9AM-4PM WEEKDAYS EXCLUDING HOLIDAYS)



1 Open box



2 Undo head clips x3



3 Note accessories and wheels in tank



4 Remove accessories



5 Turn tank upside down



6 Insert front wheels



IMPORTANT! READ AND UNDERSTAND BEFORE USING YOUR V-TUF® M-CLASS MINI LUNG SAFE DUST EXTRACTION VACUUM CLEANER

16



7 Locate rear wheels



8 Insert rear wheels (click and lock into place)



9 Turn tank right way up



10 Fit bag (ensuring that it is fully on)



11 Ensure the filter retainer screw is tight



12 Refit head and ensure all three clamps are fastened

CONTACT: CROFTON DRIVE, ALLENBY INDUSTRIAL ESTATE, LINCOLN, LN3 4NR, ENGLAND
VISIT WWW.V-TUF.COM FOR MORE INFORMATION

Specification & prices subject to change without prior notice. Images for illustration purposes only. © Fenco Group Ltd 2018 E&O.E

QUESTIONS?

PLEASE CONTACT OUR
TECHNICAL HELPLINE:
+44(0)1522 515767

(OPEN 9AM-4PM WEEKDAYS EXCLUDING HOLIDAYS)



13 Push hose end into suction port



14 Turn clockwise to lock (gently pull to ensure it is locked)



15 Fit power tool adaptor to extract dust from power tools



16 Fit Crevice Tool / Brush attachment OR...



17 Attach elbow and 2x straight extensions followed by Carpet / Hard Floor Head or Hard Floor Sweeper Head

V-TUF

V-TUF IS COMMITTED TO ELIMINATING DUST THROUGH THE DEVELOPMENT OF INNOVATIVE, EFFICIENT TOOLS AND METHODS FOR THE CONSTRUCTION INDUSTRY.

OUR MISSION IS TO EDUCATE, INNOVATE AND ERADICATE DUST ISSUES.



IMPORTANT! READ AND UNDERSTAND BEFORE USING YOUR V-TUF® M-CLASS MINI LUNG SAFE DUST EXTRACTION VACUUM CLEANER

18



★ Carpet / Hard Floor Head for deep carpet cleaning



★ Hard Floor Sweeper Head to reduce dust while sweeping



18 Plug in device then press switch to turn extraction on/off



19 Check extraction velocity monitor



20 If monitor is red, press and hold Filter Shaker button for 10 seconds to clear filter (device/extraction must be on) If the monitor turns red only as and when you connect it to your power tool, ensure that the extraction passages of your tool are not blocked. If clear, it is OK to use. Just check the flow periodically by removing the extraction hose.

CONTACT: CROFTON DRIVE, ALLENBY INDUSTRIAL ESTATE, LINCOLN, LN3 4NR, ENGLAND
VISIT WWW.V-TUF.COM FOR MORE INFORMATION

QUESTIONS?

PLEASE CONTACT OUR
TECHNICAL HELPLINE:
+44(0)1522 515767

(OPEN 9AM-4PM WEEKDAYS EXCLUDING HOLIDAYS)



- 21** If red monitor continues the bag may be full. Open device and remove bag (making sure to close gate as shown before disposal)



- 22** If red monitor continues the filter may need washing. Undo filter retainer screw, remove filter and wash with warm soap water (this can be done by hand or in dishwasher). Filter must be allowed to dry thoroughly before refitting.



- 23** Ensure the seal around the retaining screw is in place before fitting filter



- 24** Refit filter and retainer screw and tighten



IMPORTANT! READ AND UNDERSTAND BEFORE USING YOUR V-TUF[®] M-CLASS MINI LUNG SAFE DUST EXTRACTION VACUUM CLEANER

20



25 After use, cable can be wrapped around handle...



26 ...with the plug fitted into handle slot



27 To use the blow feature, simply connect the hose to the exhaust port on top of the unit (as you would to the suction port)



CONTACT: CROFTON DRIVE, ALLENBY INDUSTRIAL ESTATE, LINCOLN, LN3 4NR, ENGLAND
VISIT WWW.V-TUF.COM FOR MORE INFORMATION

QUESTIONS?

PLEASE CONTACT OUR
TECHNICAL HELPLINE:-
+44(0)1522 515767

(OPEN 9AM-4PM WEEKDAYS EXCLUDING HOLIDAYS)

THE RATING LABEL

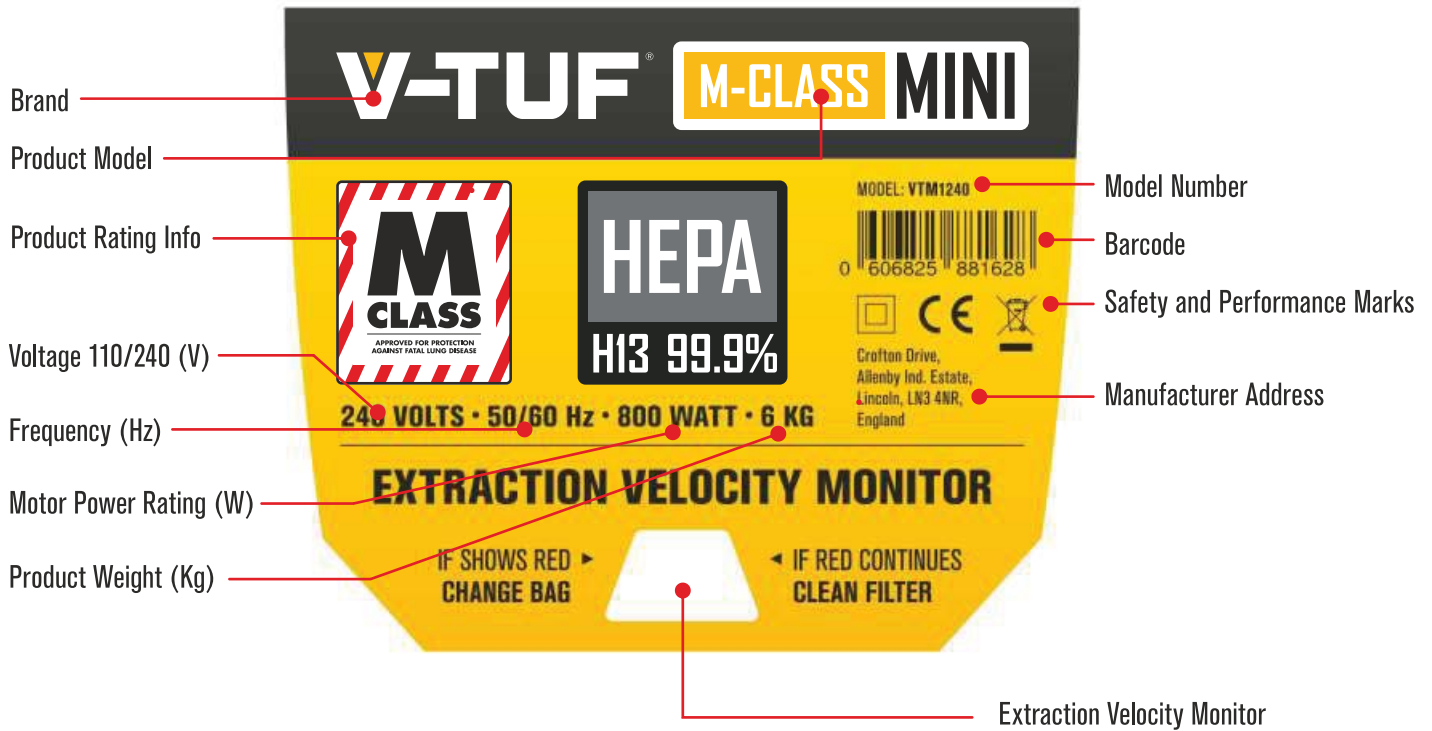

WEEE LEGISLATION

(WASTE, ELECTRICAL AND ELECTRONIC EQUIPMENT)

The machine and its accessories, along with its packaging, needs to be sorted for environmentally-friendly recycling. **This machine is not to be disposed of in household waste.**

The Waste Electrical and Electronic Equipment Directive (WEEE Directive) is the European Community directive 2012/19/EU on waste electrical and electronic equipment (WEEE) which, together with the RoHS Directive 2002/95/EC, became European Law in February 2003.

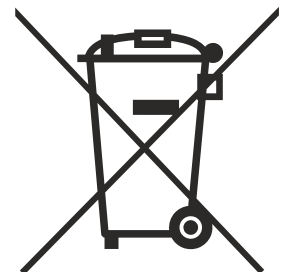

V-TUF IS COMMITTED TO ELIMINATING DUST THROUGH THE DEVELOPMENT OF INNOVATIVE, EFFICIENT TOOLS AND METHODS FOR THE CONSTRUCTION INDUSTRY.

OUR MISSION IS TO EDUCATE, INNOVATE AND ERADICATE DUST ISSUES.



IMPORTANT: PLEASE READ THESE DIRECTIVES TO ENSURE YOU GET THE BEST OUT OF YOUR MACHINE

- ✓ Clean machine with damp cloth or wipes. Never rinse or submerge.
- ✓ Ensure the Filter is correctly fitted and clean before use.
- ✓ Ensure that your cable and machine is not damaged.
- ✓ Your machine will require a 14 month LEV test to ensure the extraction and filtration quality of your machine. This is the owner's responsibility.*
- ✓ Always use the machine with a genuine V-TUF bag to ensure that you safely collect, contain and dispose of the dust.
- ✓ Disconnect machine from the power supply before repairing, modifying and when not in use.
- ✓ Operators must be sufficiently inducted on the use of this machine before use.
- ✓ Routine and preventative maintenance must be performed on this machine to ensure safety and best performance.
- ✓ Inspect the vacuum before and after use for damage. And damaged parts must be replaced with original parts.
- ✓ Store the machine inside and in a dry place.
- ✓ If your machine stops working or gets blocked, disconnect from power source before clearing or repairing your machine. Resume operation only once the blockage has been cleared or the relevant maintenance and tests have been done.
- ✓ A risk assessment should be carried out to determine if any PPE (Personal protective Equipment) should be worn in conjunction with the use of this machine and whether the waste needs to be disposed of in a controlled manner.
- ✗ NEVER use your extractor without a filter.
- ✗ This is a dry dust machine. Do not use for liquid, hot debris, acids or solvents.
- ✗ This machine is not to be used, maintained or tampered with by children or people with reduced mental or physical capabilities unless instructed or supervised.
- ✗ This machine is not suitable for use with poisonous, combustible or explosive dust.
- ✗ Keep the machine, cable and accessories away from heat and sharp or abrasive materials.
- ✗ This machine must not be stored outside where it is exposed to the elements (sun, frost, rain, etc.).
- ✗ Never tow the machine by its cable.

THIS MACHINE HAS BEEN TESTED AND CERTIFIED M-CLASS SO THAT IT PROTECTS THE OPERATOR AND OTHER PEOPLE IN THE VICINITY FROM HARMFUL AIRBORNE DUST. PLEASE READ AND UNDERSTAND THE 'M-CLASS' INSTRUCTIONS TO GUARANTEE SUFFICIENT PROTECTION (PAGE 23)

FAILURE TO ADHERE TO THE ABOVE DIRECTIVES COULD LEAD TO DAMAGE OR HARM TO WHICH THE MANUFACTURER HAS NO RESPONSIBILITY

*Contact V-TUF if you would like us to assist you with this.

**CONTACT: CROFTON DRIVE, ALLENBY INDUSTRIAL ESTATE, LINCOLN, LN3 4NR, ENGLAND
VISIT WWW.V-TUF.COM FOR MORE INFORMATION**

QUESTIONS?

PLEASE CONTACT OUR
TECHNICAL HELPLINE:
+44(0)1522 515767

(OPEN 9AM-4PM WEEKDAYS EXCLUDING HOLIDAYS)



IMPORTANT POINTS TO READ AND UNDERSTAND BEFORE USE



THE V-TUF[®]M HAS BEEN DEVELOPED TO REDUCE FATAL LUNG DISEASES CAUSED BY EXPOSURE TO HARMFUL DUST. TO FACILITATE THE BEST POSSIBLE PROTECTION, YOU NEED TO ADHERE TO THE FOLLOWING REQUIREMENTS:

- 1** Your machine may become contaminated with harmful dust. Take appropriate action to avoid exposure when handling the machine. Waste must be disposed of in the correct manner.
- 2** Repairs and maintenance must be performed in an area that protects the operative from exposure and eliminates airborne dust.
- 3** Use a moist cloth to wipe dust rather than blowing with compressed air (unless you have a sufficient local exhaust ventilation system that protects the operator and sufficiently captures the dust).
- 4** Your machine will require a 14 month LEV test to ensure that its performance is maintained.
- 5** Testing methodology can be found in IEC 60335-2.69 Annex AA (AA22.201.2). This determines the filtration efficiency. If it fails, a new genuine filter must be fitted and the test repeated until it passes.
- 6** All repair work must always be carried out by competent, authorised personnel fitted with suitable personal protection and done in an area that will not cause risk to others.
- 7** The HEPA cartridge filter must be inspected for damage to the seal, cap and filter medium.
- 8** In cases where the HEPA filter has entrenched contamination, rinse with warm water and leave to dry before use. If this fails to remove contamination, replace with a new genuine filter part. This is extremely important to ensure that you get the sufficient level of protection.
- 9** Any part of the machine must be disposed of according to current regulations.
- 10** It is important to ensure that your extraction velocity remains above 20 metres per second. The Extraction Velocity Monitor will turn red to notify when you do not have sufficient extraction. To refresh your extraction velocity, leave the extraction on and press and hold the Filter Shaker button for 10 seconds. Let go and check if the monitor is clear, if not, replace the bag. If the monitor continues to show red, remove the filter and give it a deep clean.

IMPORTANT POINTS TO NOTE WHEN REMOVING AND REFITTING THE HEPA FILTER:

Remove the head from the base and place upside down on a workbench. Undo the wingnut that secures the filter // Remove the contaminated HEPA filter and dispose of in the correct manner // Ensure the seal around the filter retaining screw is in place. There must be no gaps or objects preventing an airtight seal // Replace the HEPA filter with a genuine, identical part // Refit the filter retaining wingnut until thumb tight (torque 1.5Nm) // Recheck that the seal is constant with no gaps or items preventing an airtight seal // Replace the bag // Reposition head on the base and lock all three head clamps.



V-TUF IS COMMITTED TO ELIMINATING DUST THROUGH THE DEVELOPMENT OF INNOVATIVE, EFFICIENT TOOLS AND METHODS FOR THE CONSTRUCTION INDUSTRY.

OUR MISSION IS TO EDUCATE, INNOVATE AND ERADICATE DUST ISSUES.

WIRING DIAGRAM

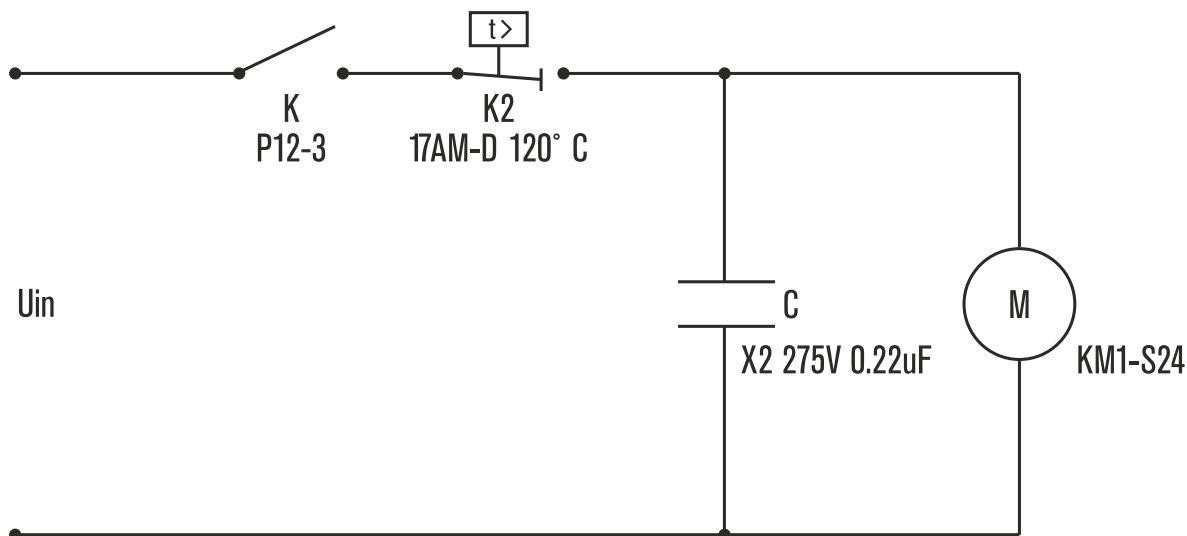

ERROR DETECTION AND TROUBLESHOOTING

Before you contact our service centre, please check the following:

| PROBLEM | POSSIBLE REASON | ADVICE |
|-------------------------|--|--|
| Motor does not start | <ul style="list-style-type: none"> - Power cord not firmly plugged into outlet - Outlet damaged - Cleaner not switched on - Start motor temperature protection | <ul style="list-style-type: none"> - Plug unit firmly - Check the outlet - Switch on the appliance - Wait ~30 minutes to restart the machine |
| Suction power is weaker | <ul style="list-style-type: none"> - Unit clogged - Dust filter needs cleaning - Dust container not in position | <ul style="list-style-type: none"> - Remove the blockage - Clean the dust filter - Reattach the dust container to the cleaner |

CONTACT: CROFTON DRIVE, ALLENBY INDUSTRIAL ESTATE, LINCOLN, LN3 4NR, ENGLAND
 VISIT WWW.V-TUF.COM FOR MORE INFORMATION

QUESTIONS?

PLEASE CONTACT OUR
 TECHNICAL HELPLINE:
 +44(0)1522 515767

(OPEN 9AM-4PM WEEKDAYS EXCLUDING HOLIDAYS)

PARTS DIAGRAM AND LIST

VTM500 (110 VOLT) / VTM501 (240 VOLT) COMPLETE HEAD KIT

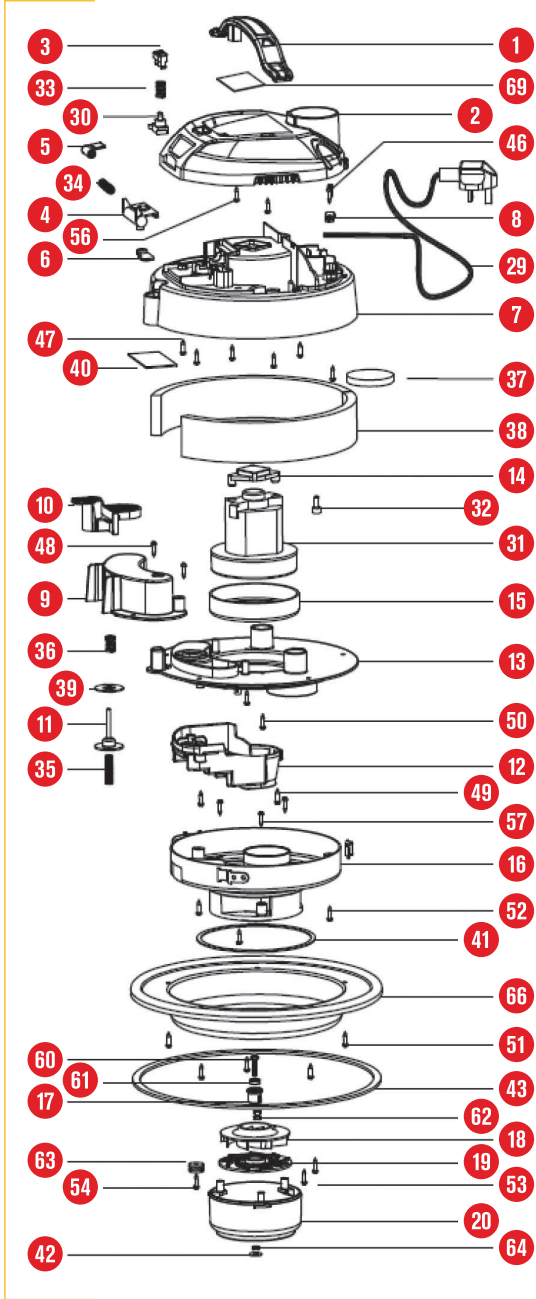

VTM503 COMPLETE ACCESSORIES KIT

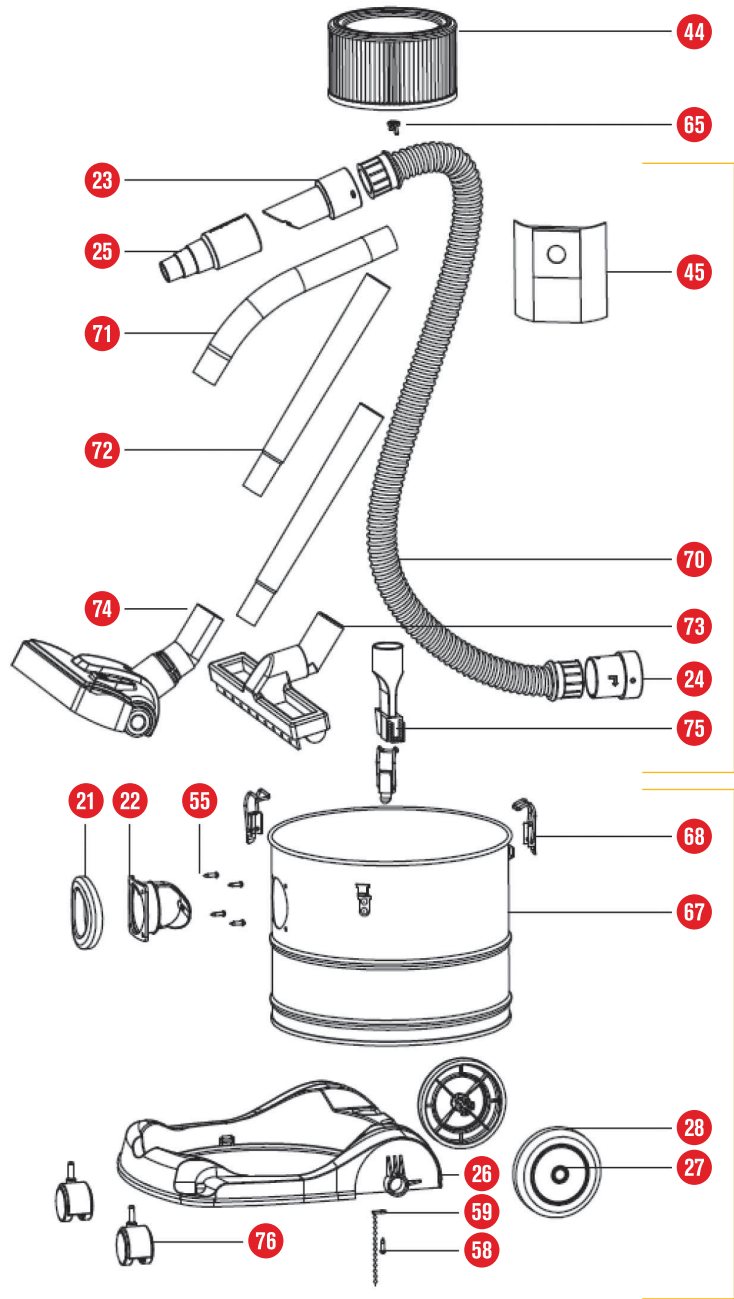

VTM502 COMPLETE BASE KIT



V-TUF IS COMMITTED TO ELIMINATING DUST THROUGH THE DEVELOPMENT OF INNOVATIVE, EFFICIENT TOOLS AND METHODS FOR THE CONSTRUCTION INDUSTRY.

OUR MISSION IS TO EDUCATE, INNOVATE AND ERADICATE DUST ISSUES.



IMPORTANT! READ AND UNDERSTAND BEFORE USING YOUR V-TUF® M-CLASS MINI LUNG SAFE DUST EXTRACTION VACUUM CLEANER

26

| PART NO. | PART NAME | MATERIAL AND SIZE | QTY PER MACHINE | ORDER CODE | STOCKED? |
|-------------|---|---|-----------------|------------|-------------|
| 1 | Handle | PP | 1 | VTM120 | NON STOCKED |
| 2 | Motor Cover | PP | 1 | VTM121 | NON STOCKED |
| 3 | Power Switch | PP | 1 | VTM122 | NON STOCKED |
| 4 | Airflow Support | PS | 1 | VTM123 | NON STOCKED |
| 5 | Airflow Indicator | PP | 1 | VTM124 | NON STOCKED |
| 6 | Airflow Seal Cover | PP | 1 | VTM125 | NON STOCKED |
| 7 | Centre Frame | PP | 1 | VTM126 | NON STOCKED |
| 8 | Electric Wire | PP | 1 | VTM127 | NON STOCKED |
| 9 | Dust Cleaning Cover | PDM | 1 | VTM128 | NON STOCKED |
| 10 | Dust Cleaning Switch | PDM | 1 | VTM129 | NON STOCKED |
| 11 | Dust Cleaning Valve | PDM | 1 | VTM130 | NON STOCKED |
| 12 | Dust Cleaning Cover | PP | 1 | VTM131 | NON STOCKED |
| 13 | Motor Base | PP | 1 | VTM132 | NON STOCKED |
| 14 | Motor Fixed block | PVC | 1 | VTM133 | NON STOCKED |
| 15 | Motor Shakeproof | PVC | 1 | VTM134 | NON STOCKED |
| 16 | Dust Cleaning Base | PP | 1 | VTM135 | NON STOCKED |
| 17 | Axle Sleeve | PDM | 1 | VTM136 | NON STOCKED |
| 18 | Shaking Wheel | PP | 1 | VTM137 | NON STOCKED |
| 19 | Shaking Wheel Cap | PP | 1 | VTM138 | NON STOCKED |
| 20 | Dust Cleaning Cover | PP | 1 | VTM139 | NON STOCKED |
| 21 | Inlet | PP | 1 | VTM140 | NON STOCKED |
| 22 | Inlet Elbow | PP | 1 | VTM141 | NON STOCKED |
| 23 | Hose Connection 1 | LDPE | 1 | VTM142 | NON STOCKED |
| 24 | Hose Connection 2 | PP | 1 | VTM143 | NON STOCKED |
| 25 | Universal Power Tool Adaptor | TPR | 1 | VTM103 | STOCKED |
| 26 | Wheel Base | PP | 1 | VTM144 | NON STOCKED |
| 27 | Rear Wheels | PP | 2 | VTM145 | NON STOCKED |
| 28 | Rear Wheels Rubber Coating | PVC | 2 | VTM146 | NON STOCKED |
| 29 | Power Cord 110 Volt | plug + H07RN-F 2x1.5mm2x5.26m | 1 | VTM147 | NON STOCKED |
| 29 | Power Cord 240 Volt | plug + H07RN-F 2x1.5mm2x5.26m | 1 | VTM148 | NON STOCKED |
| 30 | Power Switch | 8(8)A 250Vac 16A 125Vac T85 | 1 | VTM149 | NON STOCKED |
| 31 | Motor 110 Volt | capacitance 0.22uF+17AM-D temperaturecontrol 120;120V 60Hz900W | 1 | VTM150 | NON STOCKED |
| 31 | Motor 240 Volt | capacitance 0.22uF+17AM-D temperaturecontrol 120;120V 60Hz900W | 1 | VTM151 | NON STOCKED |
| 32 | Support Screw | CE5 | 1 | VTM152 | NON STOCKED |
| 33 | Power Switch Spring | with electroplate $\phi 0.6 \times \phi 11$ (external diameter) $\times 16$ (length) $\times 5$ circles | 1 | VTM153 | NON STOCKED |
| 34 | Airflow Indicator Spring | spring steel wire $\phi 0.4 \times \phi 8.7$ (external diameter) $\times 40$ (length) $\times 18$ circles | 1 | VTM154 | NON STOCKED |
| 35 | Dust Cleaning Valve Spring | spring steel wire $\phi 0.4 \times \phi 8.7$ (external diameter) $\times 40$ (length) $\times 18$ circles | 1 | VTM155 | NON STOCKED |
| 36 | Dust Cleaning Switch Spring | with electroplate $\phi 0.8 \times \phi 11$ (external diameter) $\times 40$ (length) $\times 10$ circles | 1 | VTM156 | NON STOCKED |
| 37 | Outlet Sponge | foaming rough hole-ventilate | 1 | VTM157 | NON STOCKED |
| 38 | Noise Reduction Sponge | foaming non-ventilate 303x50x10 | 2 | VTM158 | NON STOCKED |
| 39 | Dust Cleaning Valve Seal Ring | black med-elastic $\phi 35 \times \phi 15 \times 1.5$ | 1 | VTM159 | NON STOCKED |
| 40 | Transform Cover Seal Gasket | EVA black med-elastic 75x40x1.5 | 1 | VTM160 | NON STOCKED |
| 41 | Dust Cleaning Cover Seal Gasket | EVA black med-elastic 440x8x1.5 | 1 | VTM161 | NON STOCKED |
| 42 | HEPA Seal Gasket | EVA black med-elastic $\phi 45 \times \phi 5 \times 1.5$ | 1 | VTM162 | NON STOCKED |
| 43 | Vacuum Seal Strip | EVA black med-elastic 935x9x3 | 1 | VTM163 | NON STOCKED |
| 44 | Dust Filter to Fit V-TUF _M | - | 1 | VTM102 | STOCKED |
| 45 | Dust Bags to Fit V-TUF _M (pack of 5) | 8L | 1 | VTM101 | STOCKED |
| 46 | Wire Pressing Screw | ST4x16 big homocephalus | 2 | VTM164 | NON STOCKED |
| 47 | Top Cover Pressing Screw | ST4x16 big homocephalus | 6 | VTM165 | NON STOCKED |
| 48 | Transform Screw | ST4x16 big homocephalus | 2 | VTM166 | NON STOCKED |
| 49 | Seal Cover Screw | ST4x16 big homocephalus | 2 | VTM167 | NON STOCKED |
| 50 | Motor Base Pressing Screw | ST4x16 big homocephalus | 2 | VTM168 | NON STOCKED |
| 51 | Barrel Cover Screw | ST4x16 big homocephalus | 5 | VTM169 | NON STOCKED |
| 52 | Dust Cleaning Base Screw | ST4x16 big homocephalus | 3 | VTM170 | NON STOCKED |
| 53 | Shaking Wheel Screw | ST4x12 big homocephalus | 2 | VTM171 | NON STOCKED |
| 54 | Weight Block Screw | ST4x18 big homocephalus | 1 | VTM172 | NON STOCKED |
| 55 | Inlet Screw | ST4x14 big homocephalus | 4 | VTM173 | NON STOCKED |
| 56 | Handle Screw | ST4x16 big homocephalus | 2 | VTM174 | NON STOCKED |
| 57 | Dust Cleaning Cover Screw | ST4x16 big homocephalus | 3 | VTM175 | NON STOCKED |
| 58 | Static Proof Chain Screw | ST3x14 big homocephalus | 1 | VTM176 | NON STOCKED |
| 59 | Static Proof Chain | Chrome plated iron chain 8.3cm+flat button | 1 | VTM177 | NON STOCKED |
| 60 | HEPA Fixed Bolt | M5 25 | 1 | VTM178 | NON STOCKED |
| 61 | Bearing | $\phi 13$ (external diameter) $\times \phi 5$ (inner diameter) $\times 4$ (thick) dust proof | 1 | VTM179 | NON STOCKED |
| 62 | Bearing Fixed Nut | M5 locknut | 1 | VTM180 | NON STOCKED |
| 63 | Weight Gasket | A3 Zinc coating | 3 | VTM181 | NON STOCKED |
| 64 | Bolt Fixed Nut | M5 locknut | 1 | VTM182 | NON STOCKED |
| 65 | Filter Fixed Nut | M5 butterfly nut | 1 | VTM183 | NON STOCKED |
| 66 | Barrel Cover | Cold Plate with coating | 1 | VTM184 | NON STOCKED |
| 67 | Barrel | Cold Plate with coating 20L | 1 | VTM185 | NON STOCKED |
| 68 | Buckle | Iron electroplate | 3 | VTM186 | NON STOCKED |
| 69 | Rating Label | PVC with coating | 1 | VTM187 | NON STOCKED |
| 70 | 3 Metre Yellow Complete Suction Hose Assembly | 3 Metre Yellow Complete Suction Hose assembly | 1 | VTM104 | STOCKED |
| 73 | Hard Floor / Sweeper Suction Head | suction with brush on double sides | 1 | VTM107 | STOCKED |
| 74 | High-Efficiency Carpet Suction Head | ZX-38 high efficiency | 1 | VTM106 | STOCKED |
| 75 | Crevice Tool / Brush Attachment | SZ-Z1 | 1 | VTM108 | STOCKED |
| 76 | Universal Wheel | W1-40 | 2 | VTM188 | NON STOCKED |
| 71 & 72(x2) | Chrome Wand Complete (1x Elbow + 2x Extensions) | $\phi 32 \text{mm} \times 400 \text{mm}$ electroplate | 2 | VTM105 | STOCKED |
| Kits | Complete Head excluding Filter - 110 Volt | - | 1 | VTM500 | STOCKED |
| Kits | Complete Head excluding Filter - 240 Volt | - | 1 | VTM501 | STOCKED |
| Kits | Complete Base with Wheels (Excluding Bag) | - | 1 | VTM502 | STOCKED |
| Kits | Complete Accessories Kit | - | 1 | VTM503 | STOCKED |

CONTACT: CROFTON DRIVE, ALLENBY INDUSTRIAL ESTATE, LINCOLN, LN3 4NR, ENGLAND
VISIT WWW.V-TUF.COM FOR MORE INFORMATION

QUESTIONS?

**PLEASE CONTACT OUR
TECHNICAL HELPLINE:
+44(0)1522 515767**

(OPEN 9AM-4PM WEEKDAYS EXCLUDING HOLIDAYS)

V-TUF (CLEANING EQUIPMENT BRAND OF FENCO GROUP LTD.) WARRANTS TO THE CONSUMER THAT THIS PRODUCT WILL BE FREE OF MATERIAL OR ASSEMBLY DEFECTS FOR 1 YEAR.

WARRANTY PROMISE:

- **PLEASE NOTE:** This excludes wearing parts such as, hoses, floor heads, motor brushes etc. that wear out and need replacing within the normal working life of the machine.
- Warranty claims must be processed through the dealer from whom the machine was purchased. If you have any problems please contact V-TUF on the helpline number shown on the rear of this manual. Please have claim details and proof of receipt to hand.
- The warranty claim only covers the defective parts rather than the replacement of the whole machine.
- Warranty claims will need to be validated by the manufacturer's inspection of the faulty components. Where damage has been caused by misuse, wear & tear or abuse, V-TUF reserve the right to charge for the repair, transport or inspection costs.
- The warranty period commences from the purchase date.
- This warranty policy cannot be overridden by any dealer, or anyone involved in the sale of this product.

RETURNS:

- Goods ordered incorrectly will be restocked with no charge. Fenco need to be notified within 5 working days and goods must be unused and in original condition and packaging. Transport and Carriage Charges, however, will apply.
- Goods wrongly supplied, will be collected within 48hours of notification. Free of charge.
- Please ensure that someone will be present at the collection address to meet the carrier. Normal collection times are between 8am and 5pm, Monday to Friday.

REPLACEMENTS:

- We will collect all items classed as warranty. Valid warranty items will be repaired, or at the discretion of Fenco, replaced free of charge. If, however, the failure is due to misuse, the repair will be chargeable. A report, stating the reason for the failure will be provided to minimise the possibility of repeated mishandling.
- If there is a policy to offer immediate 'Service Exchange' equipment to your customers, we recommend that an adequate pool of extra units of equipment be kept in stock, as warranty replacement units can only be sent out once the faulty units have been inspected by ourselves.

REPAIRS:

- We are able to collect, repair and return any goods supplied by Fenco. The charges are minimal when compared with the call out cost of an engineer. We commit ourselves to collect within 48hours and return the goods within 1 week of agreement to repair.

PLEASE VALIDATE YOUR WARRANTY AT WWW.V-TUF.COM



V-TUF IS COMMITTED TO ELIMINATING DUST THROUGH THE DEVELOPMENT OF INNOVATIVE, EFFICIENT TOOLS AND METHODS FOR THE CONSTRUCTION INDUSTRY.

OUR MISSION IS TO EDUCATE, INNOVATE AND ERADICATE DUST ISSUES.

RETURNS AUTHORIZATION FORM

28

RETURN DATE:

PURCHASE DATE:

COMPANY NAME:

ADDRESS:

CONTACT NUMBER:

EMAIL ADDRESS:

RETURNED ITEM:

REASON FOR RETURN:

RETURNS NUMBER:

DATE OF NOTIFICATION:

FOR FENCO INTERNAL USE

DATE RECEIVED:

STAFF NAME:

COMMENTS:

ACTION REQUIRED:

COMPLETED (DATE & ACTION):

CONTACT: CROFTON DRIVE, ALLENBY INDUSTRIAL ESTATE, LINCOLN, LN3 4NR, ENGLAND
VISIT WWW.V-TUF.COM FOR MORE INFORMATION

QUESTIONS?

PLEASE CONTACT OUR
TECHNICAL HELPLINE:
+44(0)1522 515767

(OPEN 9AM-4PM WEEKDAYS EXCLUDING HOLIDAYS)

EU DECLARATION OF CONFORMITY

29



MACHINE DESCRIPTION: VACUUM CLEANER

V-TUF® M-CLASS MINI LUNG SAFE DUST EXTRACTION VACUUM CLEANER
TYPE: V-TUF® M-CLASS MINI 110 and V-TUF® M-CLASS MINI 240

MANUFACTURED BY: FENCO GROUP LTD

THE OBJECT OF THE DECLARATION DESCRIBED ABOVE IS IN CONFORMITY WITH THE RELEVANT COMMUNITY HARMONISATION LEGISLATION:

- THE EMC DIRECTIVE (2014/30/EU)
- ROHS DIRECTIVE (2011/65/EU)
- AFPS GS 2014:01 PAK
- LOW VOLTAGE DIRECTIVE (2014/35/EU)

RELEVANT STANDARDS UPON WHICH CONFORMITY IS DECLARED INCLUDE:

- EN60335-1:2012+AC:14+A11:14
- EN 60950-1:2006+A2:2013
- EN62233:2008
- EN61000-3-3:2013
- EN60335-2-2:2010+A11:12+A1:13
- EN 55022:2010
- EN55014-2:2015
- EN55014-1:2006/+A1:2009/+A2:2011
- EN 55024:2010
- EN61000-3-2:2014

A TECHNICAL CONSTRUCTION FILE FOR THIS EQUIPMENT IS RETAINED AT THE MANUFACTURER'S ADDRESS UNDER THE AUTHORISATION OF THE FOLLOWING SIGNATORY:

NAME: EUGENE BUCHNER

POSITION: TECHNICAL MANAGER

SIGNED: 

DATE: 1/03/2018

FENCO GROUP

FENCO GROUP LTD,
FENCO HOUSE, 18 CROFTON DRIVE,
ALLENBY INDUSTRIAL ESTATE,
LINCOLN, LN3 4NR, UK

GB

PLEASE NOTE: The ENERG Data plate only applies to the 240 Volt (M-CLASS MINI 240) version as the 110 Volt (M-CLASS MINI 110) version is exempt to this law.

V-TUF

V-TUF IS COMMITTED TO ELIMINATING DUST THROUGH THE DEVELOPMENT OF INNOVATIVE, EFFICIENT TOOLS AND METHODS FOR THE CONSTRUCTION INDUSTRY.

OUR MISSION IS TO EDUCATE, INNOVATE AND ERADICATE DUST ISSUES.

V-TUF

DISTRIBUTED BY:

GET IN TOUCH

 WWW.V-TUF.COM

 ENQUIRIES@V-TUF.COM

 [@VTUFPRODUCTS](https://twitter.com/VTUFPRODUCTS)

 SALES@V-TUF.COM

 [/VTUFPRODUCTS](https://www.facebook.com/VTUFPRODUCTS)

 01522 515 767

 V-TUF, ALLENBY INDUSTRIAL ESTATE, LINCOLN LN3 4NR

V-TUF IS A FENCO GROUP BRAND. FOR MORE INFORMATION VISIT: WWW.FENCOGROUP.COM